

THE INDUSTRY LEADER IN ELECTRIC BOOSTER WATER HEATERS



QUALITY



RELIABILITY



SERVICE



PERFORMANCE



**WHEN IT COMES TO FOODSERVICE  
SANITATION, NO ONE CAN AFFORD TO TAKE  
RISKS. WHEN IT COMES TO SELECTING A  
HOT WATER BOOSTER HEATER FOR YOUR  
DISHWASHER, HATCO IS THE BEST CHOICE  
YOU CAN MAKE.**



# WHY ARE BOOSTER WATER THE BEST IN THE

## #1 IN QUALITY AND RELIABILITY

- 50 years as the proven industry leader, providing foodservice operators with Booster Water Heaters that are essential to clean and sanitize dishware.
- Castone® lined steel tanks are non-toxic and non-corrosive, meeting and exceeding UL and NSF standards, and include a full 10-year warranty.
- Lifetime warranty against perforation on the heavy-duty stainless steel front panel and the hammertone (powdercoated steel) jacket and base.

- Utilization of exclusive multi-element design and the lower watt density (watts per square inch) provide maximum element life and increased reliability.
- New ambient compensating thermostats accurately maintain the water rinse temperature in any dishroom environment
- Heavy-duty four-bolt flanges and flat fiber gaskets provide elements with an extremely reliable seal to the tank, and are also easy to service.

## #1 IN PERFORMANCE

- Over 100 Imperial and Compact models and configurations available to ensure that your booster water heater is perfectly sized to match with your warewasher. (Models from 4kW to 58.5kW)
- Complete confidence that 180°F (82°C) sanitizing rinse water is always available when you need it to kill dangerous bacteria and remove unsightly residue from dishware.
- Step Loading – a Hatco exclusive! Large Imperial models offer three banks of elements with separate thermostats for each bank. The multiple thermostats provide step loading for quick response to peak dishwashing demands while conserving energy and reducing cost.



# HEATERS INDUSTRY?



- Every Hatco Booster Water Heater is internally pre-plumbed, pre-wired, individually calibrated for low-temp or high temp applications, and *fully factory-tested* to our rigid quality control standards.
- *New enhanced low-water probe design* that is more resistant to false signals due to liming.
- *New time delay low-water cut-off* eliminates chattering of contactor controls and increases component life.

## #1 IN SERVICE AND DELIVERY

- *Quick-Ship inventory* – dozens of models available for immediate shipment, all of the time. When your warewasher goes down – you need help NOW! With Hatco's Midwest manufacturing location, we can quickly ship coast-to-coast and at the best rates available.

- *Personalized customer service.* Hatco prides itself on being easy to do business with and we strive for 100% customer satisfaction. An established network of Sales Representatives, Dealers, Distributors, and Service Agencies ensure customer care is available anywhere in the world.
- *24/7 service assistance* in U.S. and Canada. Hatco's 24/7 factory support is backed by a network of over 500 authorized Service Agents and more than 90 Parts Distributors in the U.S.A. and Canada.
- *An industry-leading warranty* that offers "bumper-to-bumper" coverage for the first year, a ten-year tank warranty and a lifetime jacket, front cover, and base warranty.
- All Hatco Booster Heaters are *UL, NSF, and cUL or CSA approved.* Many Compact models are also CE approved.

Other booster manufacturers may try to imitate Hatco, but only a Hatco booster heater provides the most cost-effective solutions to hot water sanitizing, while keeping the highest quality paramount. Our commitment to excellence is supported by our decades of proven reliability as the brand you can trust.

If you buy, sell, or specify a dishware sanitizing system, choose the best hot water booster available... choose Hatco.



**Rugged cabinet construction to withstand dishroom abuse.**



**Thick energy-saving insulation minimizes heat loss.**



**Castone® lined steel tank with 10-year parts warranty – non-toxic and non-corrosive.**



**Metal sheathed heating elements with four-bolt flange provides water tight seal to tank. Replaceable with common tools.**



**Powdercoated body and base with lifetime perforation warranty.**



**Heavy-duty 6" (152 mm) adjustable legs accommodate uneven dishroom floors.**



**Power connection through trade size knockouts.**

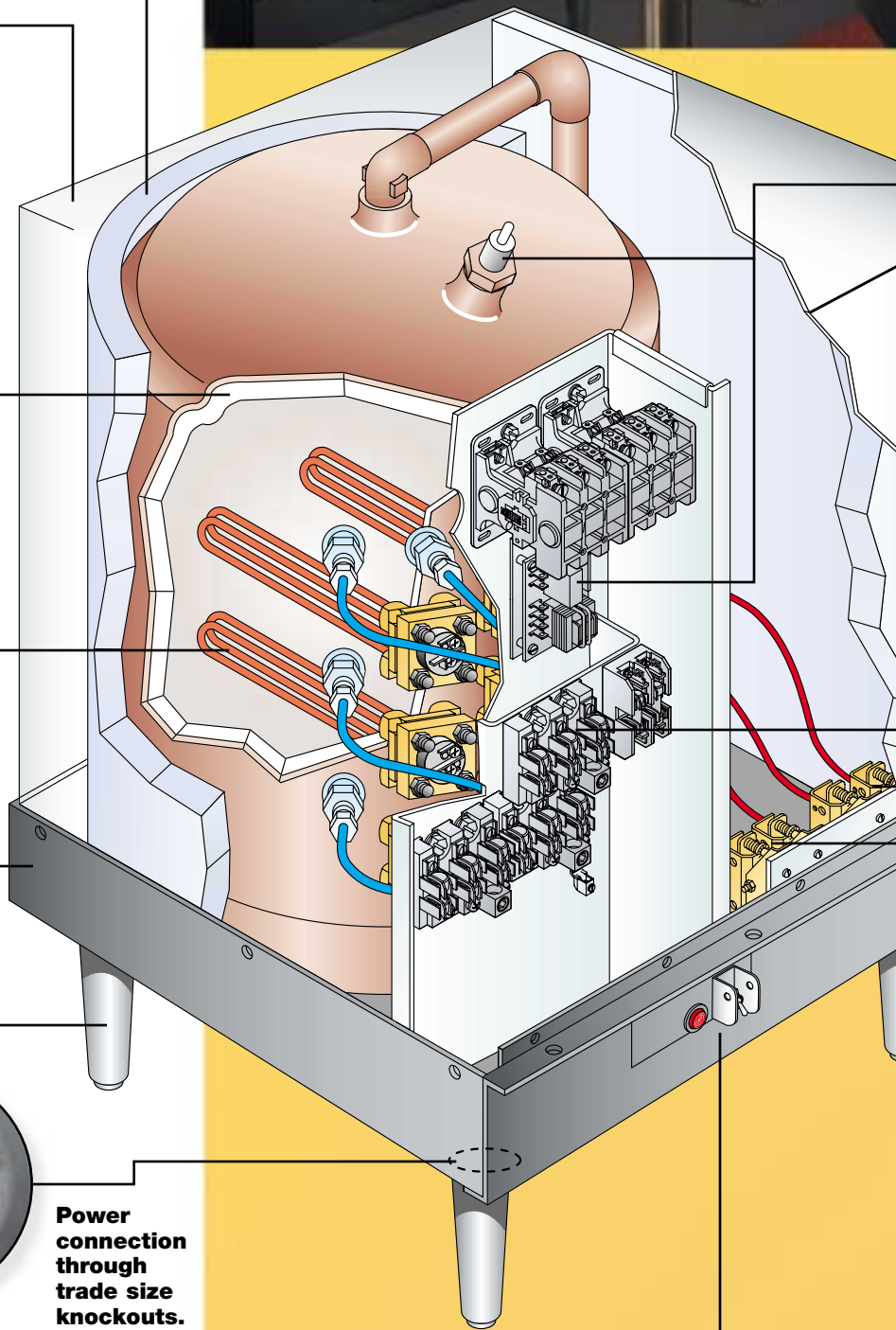

\* 24kW and larger Imperial models feature Hatco's exclusive Step Loading. Three banks of elements with separate thermostats for each bank provide a quick response for peak dishwashing demands.



## **GIVE YOUR OPERATION A REALLY BIG BOOST.**

**IMPERIAL...** Hatco's largest electric booster water heater provides up to 600 gph (2226 lph) of hot sanitizing rinse water. Models are available from 6kW to 58.5kW with a storage capacity of 16 gallons (60 liters). All models feature the exclusive Hatco Castone® tank, low-water cut-off to prevent element burnout, temperature/pressure relief valve, cast iron pressure reducing valve, two temperature/pressure gauges, indicator light, and on/off switch. Options available include stainless steel body and base, blended phosphate water treatment system, shock absorber to prevent water hammer, brass pressure reducing valve, stainless steel adjustable legs, and deck mounting legs.

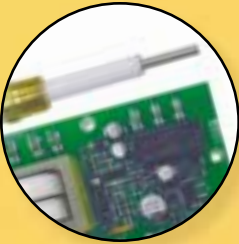

**Time delay low-water cut-off system prevents element burnout.**



**Stainless steel front cover with drip-proof design.**



**Over current circuit protection when required.**



**Easy access to resettable safety high limit control.**



**Factory pre-set ambient compensating thermostats maintain accurate water rinse temperature in any dishroom environment.\***



**Indicator light shows operator when booster is in operation. On/off toggle switch enables booster to be turned off in periods of non-use.**





**Rugged cabinet construction to withstand dishroom abuse.**

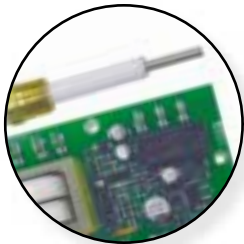

**Time delay low-water cut-off system prevents element burnout.**



**Stainless steel front cover with drip-proof design.**

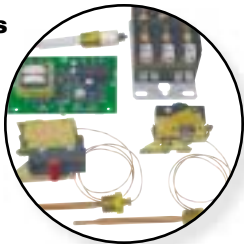

**Individual controls (thermostat, high limit, low-water cut-off system, contactors) provide low cost repairs in the event of a failure.**



**Indicator light shows operator when booster is in operation. On/off toggle switch enables booster to be turned off in periods of non-use.**



**Ambient compensated thermostat maintains accurate water rinse temperature in any dishroom environment.**



**Easy access to resettable safety high limit control.**



**Metal sheathed heating elements with four-bolt flange provides water tight seal to tank. Replaceable with common tools.**

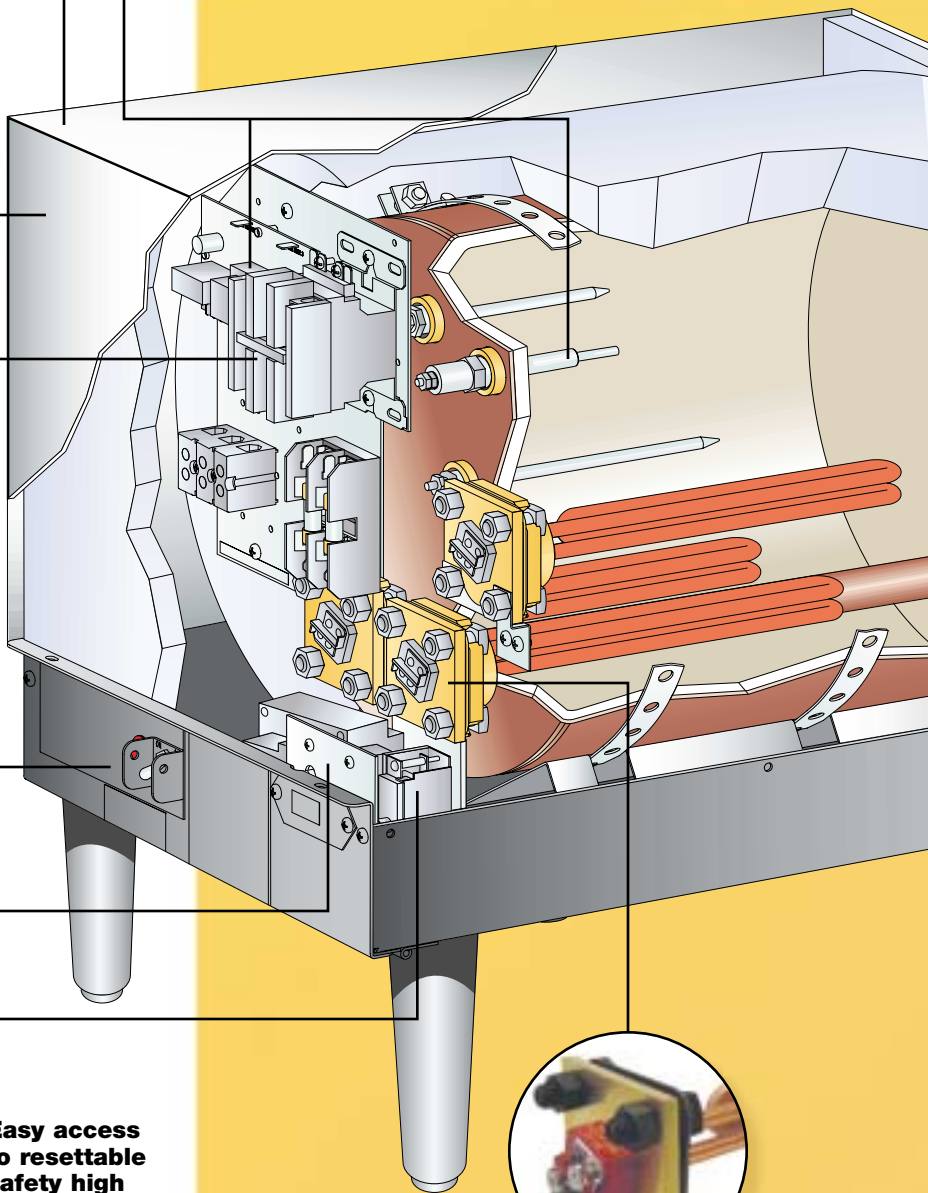



**OUR COMPACT MODELS  
 WILL FIT RIGHT IN.**

**COMPACT...** space-saving models easily fit under a dishtable or on the floor next to the dishwasher. Available in sizes ranging from 4kW to 58.5kW with a storage capacity of 6 gallons (23 liters). Features include the exclusive Hatco Castone® tank, low-water cut-off to prevent element burnout, temperature/pressure relief valve, cast iron pressure reducing valve, two temperature/pressure gauges, indicator light, and on/off switch. Options available include slide brackets for mounting under a dishtable, stainless steel body and base, blended phosphate water treatment system, shock absorber to prevent water hammer, brass pressure reducing valve, stainless steel adjustable legs, and deck mounting legs.

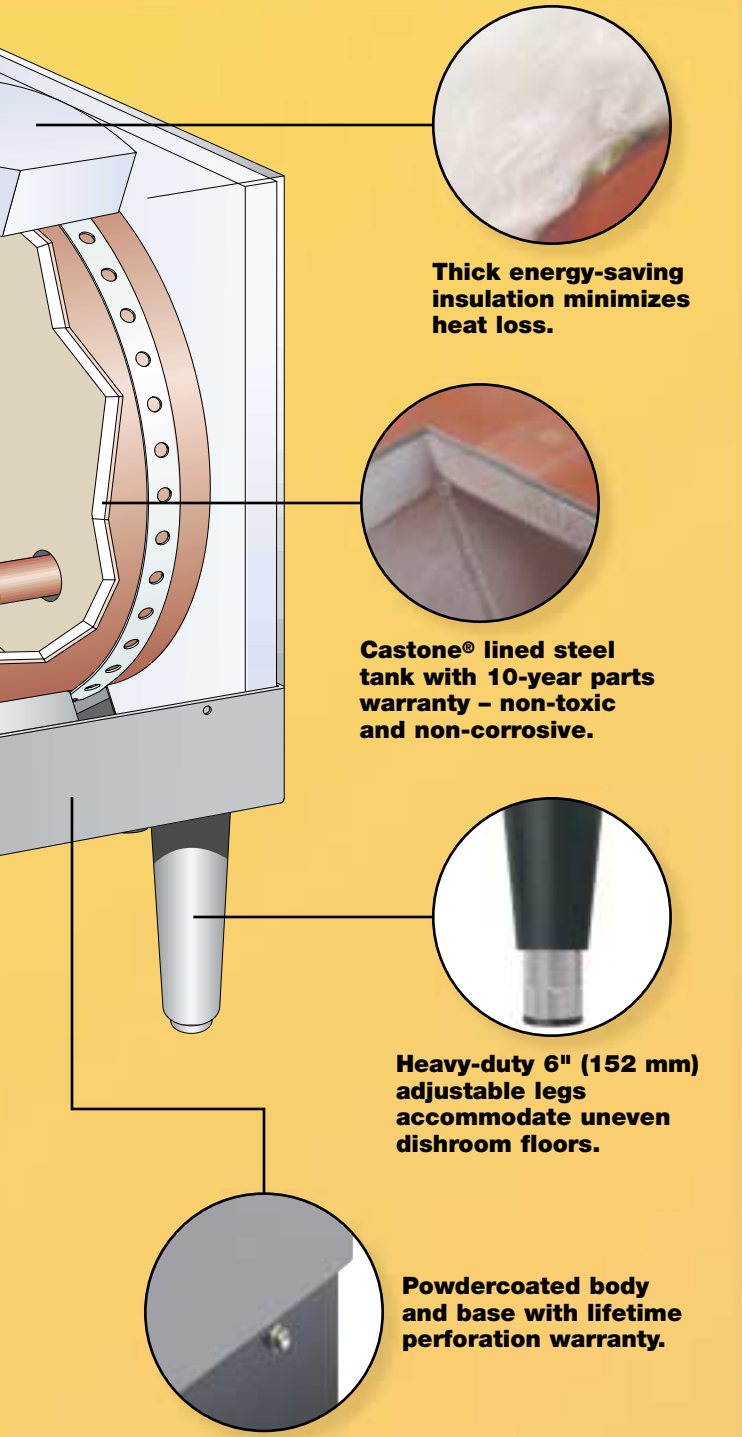

**Thick energy-saving insulation minimizes heat loss.**

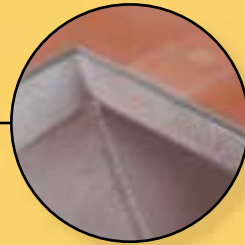

**Castone® lined steel tank with 10-year parts warranty – non-toxic and non-corrosive.**



**Heavy-duty 6" (152 mm) adjustable legs accommodate uneven dishroom floors.**



**Powdercoated body and base with lifetime perforation warranty.**



## THE QUALITY IS BUILT-IN THE FEATURES STAND OUT.

Just look at what you get inside a quality Hatco electric booster water heater.

The standard features others make optional... the built-in quality others don't have. Engineered with your operation in mind, Imperial and Compact models include the exclusive Hatco Castone® tank with its standard 10-year parts warranty and the low-water cut-off control, designed to prevent element burnout. Notice the rugged construction that includes an easy-access stainless steel front panel and hammertone powdercoated silver gray body. It all adds up to the most dependable long-life booster water heater you can buy... only from Hatco.

### ALL THE EXTRAS...

**Stainless Steel Body & Base** provides extra durability and excellent corrosion resistance for years of dependable service.



**Stainless Steel Leg** adjustable from 6" to 7½" (152 to 191 mm). Gives unit a clean appearance. Heavy-duty construction for long wear.



**Floor Mounting Hardware** 6" (152 mm) corrosion-resistant stainless steel legs for deck mounting are available.

**Shock Absorber** is recommended between the booster and dishwasher on all installations to prevent water hammer.



**Slide Bracket** for mounting the booster heater under a dishtable. (Available on COMPACT models only).

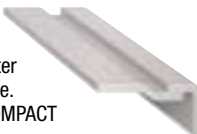

**Pressure Reducing Valve** with built-in by-pass for installation on the booster supply line. Made of brass.



**Blended Phosphate Water Treatment System** stops mineral scale by introducing a measured amount of polyphosphate into the water.

## WATER TEMPERATURE RECOVERY TABLE

Compact Model	Imperial Model	kW	40°F (22°C) Rise	70°F (39°C) Rise
C-4	-	4	40 gph ( 151 lph)	23 gph ( 87 lph)
C-5	-	5	50 gph ( 189 lph)	29 gph ( 110 lph)
C-6	S-6	6	60 gph ( 227 lph)	34 gph ( 129 lph)
C-7	S-7	7	70 gph ( 265 lph)	40 gph ( 151 lph)
C-9	S-9	9	90 gph ( 341 lph)	52 gph ( 197 lph)
C-12	S-12	12	120 gph ( 454 lph)	69 gph ( 261 lph)
C-13	S-13	13.5	135 gph ( 511 lph)	77 gph ( 292 lph)
C-15	S-15	15	151 gph ( 572 lph)	86 gph ( 326 lph)
C-17	S-17	17.25	173 gph ( 655 lph)	99 gph ( 375 lph)
C-18	S-18	18	181 gph ( 685 lph)	103 gph ( 390 lph)
C-24	S-24	24	241 gph ( 912 lph)	138 gph ( 522 lph)
C-27	S-27	27	271 gph ( 1026 lph)	155 gph ( 587 lph)
C-30	S-30	30	301 gph ( 1139 lph)	172 gph ( 651 lph)
C-36	S-36	36	361 gph ( 1367 lph)	206 gph ( 780 lph)
C-39	S-39	39	391 gph ( 1480 lph)	224 gph ( 848 lph)
-	S-40	40.5	407 gph ( 1541 lph)	232 gph ( 878 lph)
C-45	S-45	45	452 gph ( 1711 lph)	258 gph ( 977 lph)
C-54	S-54	54	542 gph ( 2052 lph)	310 gph ( 1174 lph)
C-58	S-58	58.5	588 gph ( 2226 lph)	335 gph ( 1268 lph)

### SINGLE BOOSTER INSTALLATION

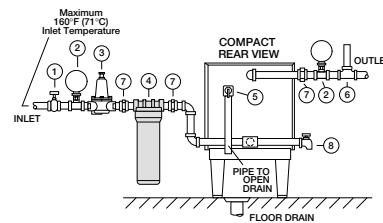

### DUAL BOOSTER INSTALLATION

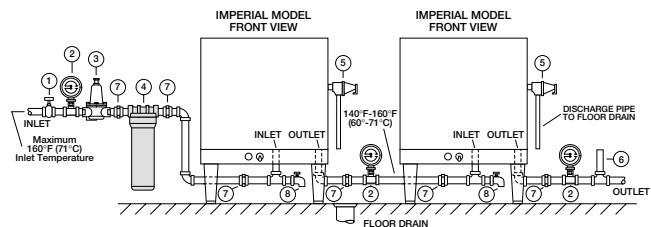

- ① ½" Gate or Ball Valve ② Temperature/Pressure Gauge ③ Pressure Reducing Valve with By-Pass  
 ④ Blended Phosphate Water Treatment System ⑤ Relief Valve (must have discharge pipe to floor drain)  
 ⑥ Shock Absorber ⑦ Union\* ⑧ Drain Pipe Valve\* \*Supplied by installer **CONSULT LOCAL CODES**

**NOTE:** Minimum differential temperature between outlet and inlet temperatures should never be less than 20°F (7°C).

**NOTE:** Thermostat calibration, or adjustment, must be performed at time of installation and is excluded from warranty coverage. Thermostat adjustments for Low-Temp applications are the responsibility of the installer.

#### WATER QUALITY REQUIREMENTS

Incoming water in excess of 3.0 grains of hardness per gallon (GPG) (.75 grains of hardness per liter) must be treated and softened before being supplied to booster heater(s). Water containing over 3.0 GPG (.75 GPL) will decrease the efficiency and reduce the operating life of the unit.

**NOTE:** Product failure caused by liming or sediment buildup is not covered under warranty.

**MC-10**



**MC-10 MINI-COMPACT**

A small speciality heater that can be installed almost anywhere. Ideal for either hot water sanitizing or point-of-use hot water dispensing. Available in two models: 10kW and 11kW, both with a storage capacity of 3.2 gallons (12 liters). Features include a stainless steel tank and fast recovery. Options include all stainless steel body and base, blended phosphate water treatment system, brass pressure reducing valve, stainless steel adjustable legs, and deck mounting legs.

**3CS2**



**3CS2 HYDRO-HEATER**

Fitting under the center of the sink, the 3CS2 is perfect for 3 or 4 compartment sinks, pot and pan sinks and bar sinks with 180°F to 190°F (82°-88°C) controls. The Hatco Hydro-Heater is a state-of-the-art, high efficiency circulation water heater, using a combination of “free-flow” technology and advanced electronic controls for circulating hot water by natural convection in a sanitizing sink. Hydro-Heater features a tubular water chamber with heating elements uniquely wrapped outside the flow tube so elements do not come in direct contact with the water.

**3CS**



**3CS SINK HEATER**

For 3 or 4 compartment sinks, pot and pan sinks, and bar sinks. The 3CS Sink Heater makes manual warewashing safe and sanitary. Maintaining a continuous supply of sanitizing hot rinse water without taking up valuable sink space, there are models available from 3kW to 9kW. The 3CS Sink Heater features a unique dual reservoir system... one with heating element; the other traps and collects soil.

## IMPERIAL BOOSTER HEATER

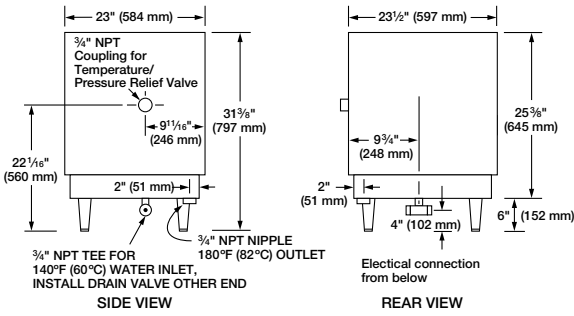

Model	kW	Shipping Weight
S-6*	6	200 lbs. (91 kg)
S-7*	7	200 lbs. (91 kg)
S-9*	9	200 lbs. (91 kg)
S-12	12	200 lbs. (91 kg)
S-13	13.5	200 lbs. (91 kg)
S-15	15	200 lbs. (91 kg)
S-17*	17.25	200 lbs. (91 kg)
S-18 <sup>§</sup>	18	200 lbs. (91 kg)

Model	kW	Shipping Weight
S-24	24	214 lbs. (97 kg)
S-27	27	214 lbs. (97 kg)
S-30	30	214 lbs. (97 kg)
S-36	36	214 lbs. (97 kg)
S-39	39	214 lbs. (97 kg)
S-40	40.5	224 lbs. (102 kg)
S-45*	45	224 lbs. (102 kg)
S-54**	54	224 lbs. (102 kg)
S-58**	58.5	224 lbs. (102 kg)

## COMPACT (4-18kW) BOOSTER HEATER

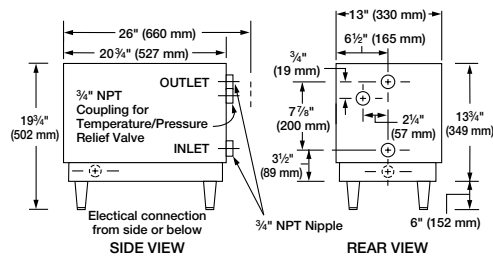

## COMPACT (24-58kW) BOOSTER HEATER

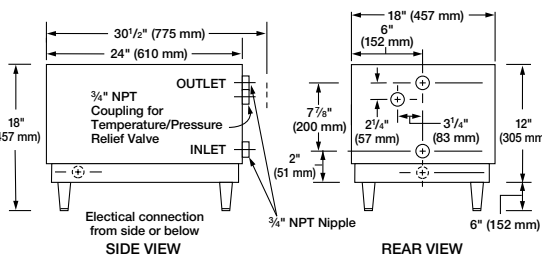

### COMPACT (4-18kW)

Model	kW	Shipping Weight
C-4 <sup>▲</sup>	4	105 lbs. (48 kg)
C-5 <sup>▲</sup>	5	105 lbs. (48 kg)
C-6*	6	118 lbs. (54 kg)
C-7*	7	118 lbs. (54 kg)
C-9*	9	118 lbs. (54 kg)
C-12	12	120 lbs. (54 kg)
C-13	13.5	120 lbs. (54 kg)
C-15	15	120 lbs. (54 kg)
C-17*	17.25	120 lbs. (54 kg)
C-18 <sup>§</sup>	18	120 lbs. (54 kg)

### COMPACT (24-58kW)

Model	kW	Shipping Weight
C-24	24	142 lbs. (64 kg)
C-27	27	142 lbs. (64 kg)
C-30	30	142 lbs. (64 kg)
C-36	36	142 lbs. (64 kg)
C-39	39	142 lbs. (64 kg)
C-45*	45	142 lbs. (64 kg)
C-54**	54	142 lbs. (64 kg)
C-58**	58.5	142 lbs. (64 kg)

**VOLTAGE:** Available in 208, 240, and 480 volts. Export voltages available, consult factory.

- \* Only 6, 7, & 9kW Models, 208 and 240V only, can be field converted to single phase (units are shipped 3-phase open delta). Larger branch circuit required than for balanced 3-phase of equal kW. (Balanced 3-phase available, consult factory.)
- † 17.25kW models available in 208V 3-phase only.
- § 18kW models not available in 208V 3-phase.

- Not available in 208V single phase.
- \*\* Not available in 208V or 240V single phase.
- ▲ 480V available in single phase only.
- † Available in 10.5kW, consult factory for details.
- † Balanced 3-phase.
- Open delta on 3-phase. Larger circuit required than for balanced 3-phase of equal kW.

## MINI-COMPACT SPECIALTY HEATER

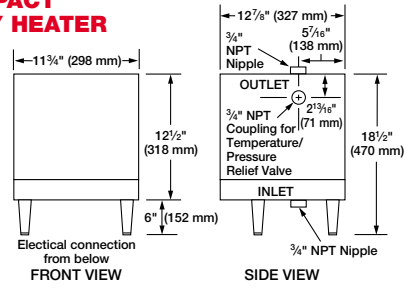

Model	kW†	Phase	Voltage	Shipping Weight
MC-10	9.9	1 or 3	208 volts	48 lbs. (22 kg)
MC-11	11.4	1 or 3	240 volts	48 lbs. (22 kg)

**VOLTAGE:** Available in 208, 240, and 480 volts.

## 3CS2 HYDRO-HEATER SANITIZING SINK HEATER

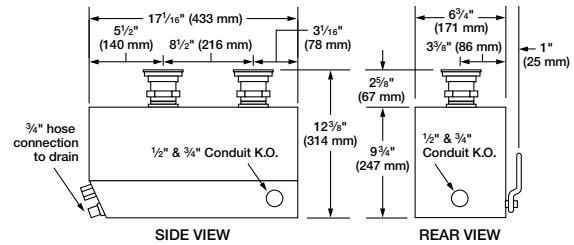

Model	kW	Phase	Sink Area	Shipping Weight
3CS2-3	3	1	15" (381 mm) Sq. or less	24 lbs. (11 kg)
3CS2-4	4	1	16"-18" (406-457 mm) Sq.	24 lbs. (11 kg)
3CS2-6	6	1	19"-21" (483-533 mm) Sq.	27 lbs. (12 kg)
3CS2-3B†	3	3	15" (381 mm) Sq. or less	24 lbs. (11 kg)
3CS2-4B†	4	3	16"-18" (406-457 mm) Sq.	24 lbs. (11 kg)
3CS2-6B†	6	3	19"-21" (483-533 mm) Sq.	27 lbs. (12 kg)
3CS2-9B†	9	3	21"-25" (533-635 mm) Sq.	27 lbs. (12 kg)

**VOLTAGE:** 208 or 240 volts, 50/60 Hz standard.

## 3CS THIRD COMPARTMENT SINK HEATER

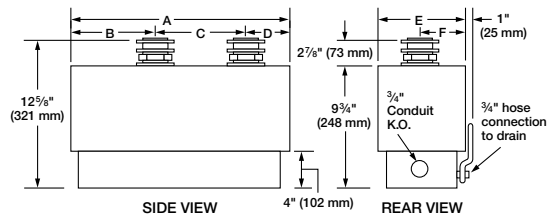

Model	kW	Phase	Sink Area	Shipping Weight
3CS-3	3	1	15" (381 mm) Square or less	24 lbs. (11 kg)
3CS-4	4.5	1	16"-18" (406-457 mm) Sq.	24 lbs. (11 kg)
3CS-6	6	1 or 3 <sup>■</sup>	19"-21" (483-533 mm) Sq.	27 lbs. (12 kg)
3CS-9	9	1 or 3 <sup>■</sup>	21"-25" (533-635 mm) Sq.	27 lbs. (12 kg)
3CS-3B†	3	3	15" (381 cm) Square or less	30 lbs. (14 kg)
3CS-4B†	4.5	3	16"-18" (406-457 mm) Sq.	30 lbs. (14 kg)
3CS-6B†	6	3	19"-21" (483-533 mm) Sq.	30 lbs. (14 kg)
3CS-9B†	9	3	21"-25" (533-635 mm) Sq.	30 lbs. (14 kg)

Model	A	B	C	D	E	F
1- or 3-phase	16 7/8" (429 mm)	5 1/2" (140 mm)	8 1/2" (216 mm)	2 7/8" ( 73 mm)	6 3/4" (171 mm)	3 3/8" ( 86 mm)
Bal. 3-phase	17 1/8" (435 mm)	4 5/8" (117 mm)	8 1/2" (216 mm)	4" (102 mm)	8" (203 mm)	4" (102 mm)

**VOLTAGE:** Available in 208 and 240 volts, 50/60 Hz. 480 volt and CSA wiring for Canada available. Export voltages available.



Nothing less than the best.™

P.O. Box 340500  
 Milwaukee, WI 53234-0500 U.S.A.  
 (800) 558-0607 (414) 671-6350  
 Fax: (800) 543-7521 Int'l. Fax: (414) 671-3976  
 www.hatcocorp.com  
 E-mail: equipsales@hatcocorp.com

