



Model shown KRD-41S (5 pan capacity)

**Product Details****Specifications**

Kairak's versatile Drop-in Pan Chillers can easily be retrofitted into existing counters or can be designed into new counters (refrigerated/non-refrigerated). These practical components can be used not only for chef prep counters, but also for buffet stations, serving lines, and specialty carts (i.e. salsa bars, condiment stations, etc.)

**Finish**

Units have a stainless steel top frame, stainless steel inner pan and chiller plated, and stainless steel outer wrap.

**Insulation**

Nominal two (2) inch thick foamed-in-place polyurethane.

**Cut-out Sizes**

Upon installation, cut out dimensions should be 1/2" smaller than length and width of model (see dimensional data for details).

**Refrigeration**

Hermetic condensing unit is provided and enclosed in a 18-gauge galvanized metal housing. Units are furnished complete with capillary tube, thermostat and time clock.

**Electrical**

Self-contained units 12 amps or less are equipped with 15 amp cord and plug (NEMA 5-15P). All hook-ups at rear. Ready for job site hook up.

**Warranty**

One (1) Year Parts & Labor  
Five (5) Year Compressor

**Models**

KRD-27S	27" Length	3 Pan
KRD-34S	34" Length	4 Pan
KRD-41S	41" Length	5 Pan
KRD-48S	48" Length	6 Pan
KRD-55S	55" Length	7 Pan
KRD-62S	62" Length	8 Pan
KRD-69S	69" Length	9 Pan
KRD-76S	76" Length	10 Pan
KRD-83S	83" Length	11 Pan
KRD-90S	90" Length	12 Pan

**Features & Benefits**

- » Patented Technology – Designed with refrigeration running through each divider bar to ensure direct contact with condiment pans, always keeping food fresh and preventing waste.  
US Patent – 5,355,687 and 5,927,092
- » Flush Mounted Design – Heavy duty stainless steel flush mounted raised rail with slight slope. Prevents corrosion and deterioration from foods (acid based foods) spilling into pan chiller compartment and also makes pans easier to reach.
- » Maximum Versatility – Can be designed to accommodate different pan configurations/sizes depending on menu requirements (horizontal divider bars available)
- » NSF Approved – Pan chilling system ensures your product always stays fresh regardless of unpredictable ambient temperatures!

**Optional Features**

- » Heavy-duty hinged night cover
- » Horizontal divider bars to hold 1/3, 1/6, or 1/9 sized pans
- » Raised rails (slightly sloped)
- » Extra depth Pan Chiller (consult factory)
- » Remote option



KRD / 5-18-2010  
Made in the U.S.A.

**Product Specifications**

<b>DIMENSIONAL DATA</b>	KRD-27S	KRD-34S	KRD-41S	KRD-48S	KRD-55S	KRD-62S	KRD-69R	KRD-76R	KRD-83R	KRD-90R
Length in.	27	34	41	48	55	62	69	76	83	90
Depth in.	16.25	16.25	16.25	16.25	16.25	16.25	16.25	16.25	16.25	16.25
Height in.	11.25	11.25	11.25	11.25	11.25	11.25	11.25	11.25	11.25	11.25
Pan Capacity 1/3 size pan	3	4	5	6	7	8	9	10	11	12
Cut-out Dimensions in.	26.625x15	33.625x15	40.625x15	47.625x15	54.625x15	61.625x15	68.625x15	75.625x15	82.625x15	89.625x15

**ELECTRICAL DATA**

Voltage	115/60/1	115/60/1	115/60/1	115/60/1	115/60/1	115/60/1	115/60/1	115/60/1	115/60/1	115/60/1
Full Load Amperes	8.6	8.6	8.6	8.6	8.6	8.6	1	1	1	1
NEMA	5-15P	5-15P	5-15P	5-15P	5-15P	5-15P	Remote	Remote	Remote	Remote

**REFRIGERATION DATA**

Refrigerant	R-134a	R-134a	R-134a	R-134a	R-134a	R-134a	Remote	Remote	Remote	Remote
H.P.	1/3	1/3	1/3	1/3	1/3	1/3	2588	2880	3171	3463

**SHIPPING DATA**

Shipping Weight	180	200	220	250	270	310	180	195	210	225
-----------------	-----	-----	-----	-----	-----	-----	-----	-----	-----	-----

**Comments:**

**Drop-in Pan Chillers**

**KRD-27S Plan View**

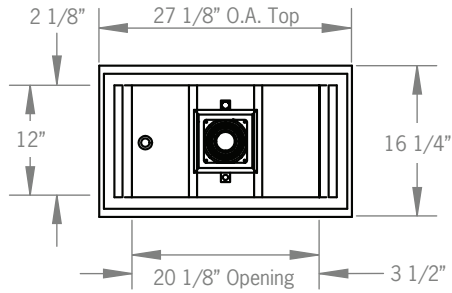

**Elevation View**

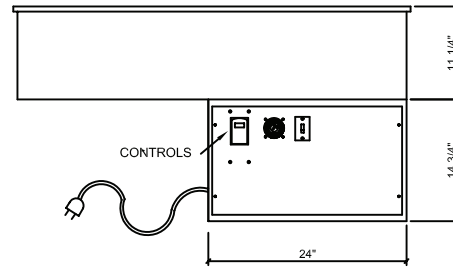

**KRD-34S Plan View**

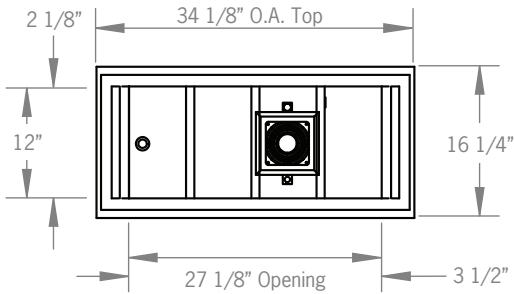

**Flat Rail Section View**

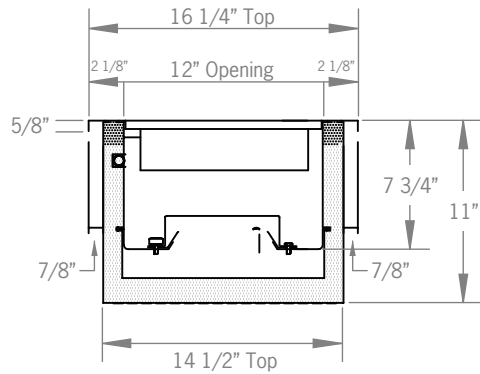

**KRD-41S Plan View**

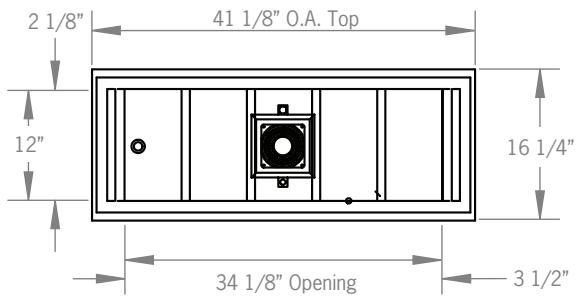

**Raised Rail Section View**

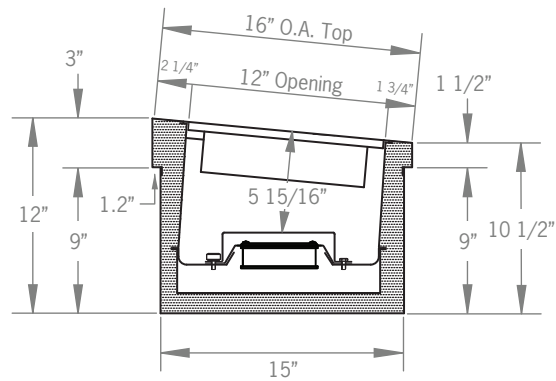

**Drop-in Pan Chillers**

**KRD-48S Plan View**

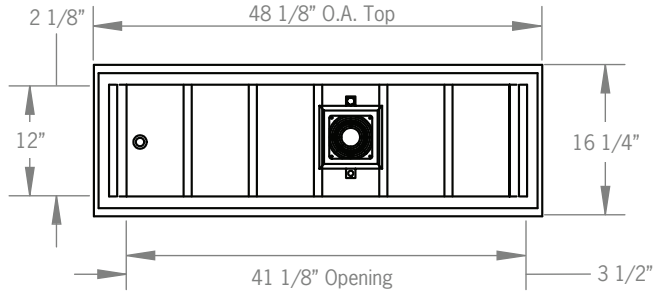

**Elevation View**

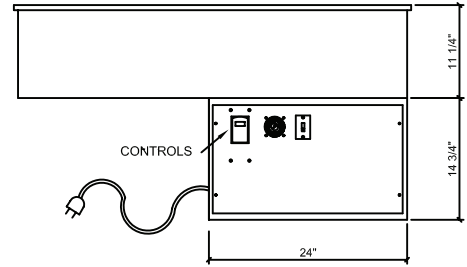

**KRD-55S Plan View**

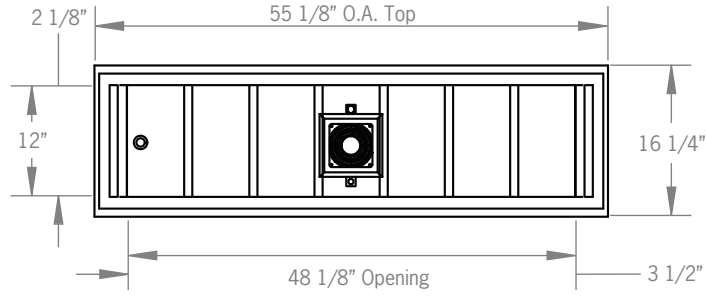

**KRD-62S Plan View**

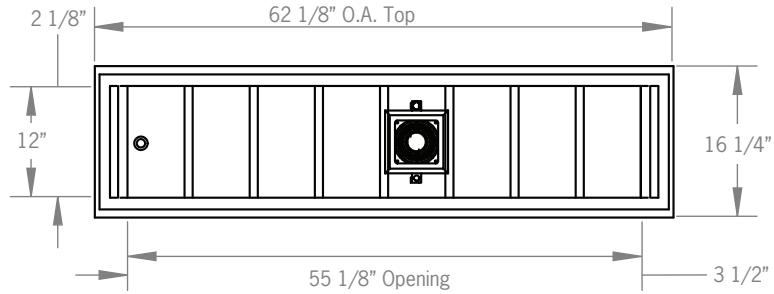

# Drop-in Pan Chillers

**KRD-69S Plan View**

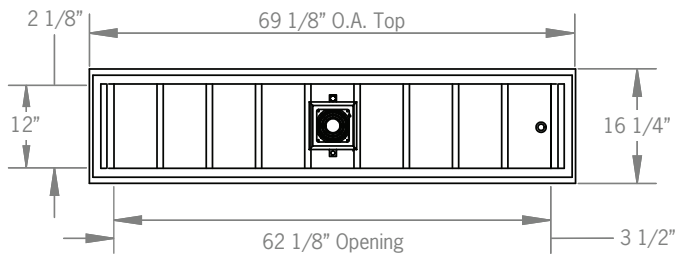

**Elevation View**

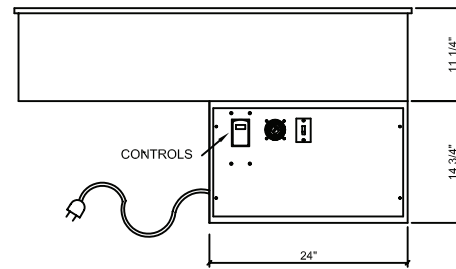

**KRD-76S Plan View**

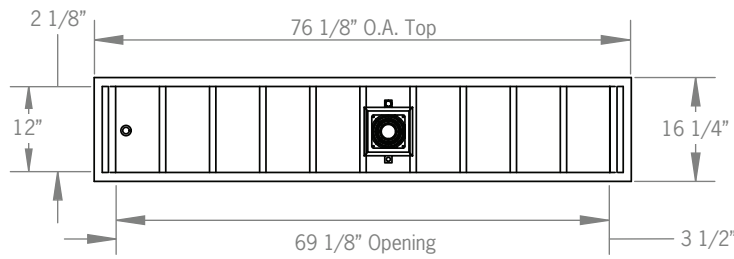

**KRD-83S Plan View**

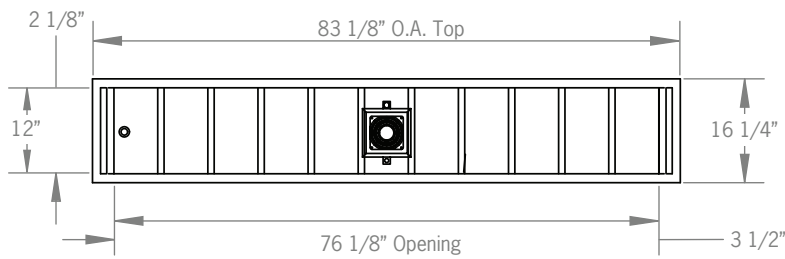

**KRD-90S Plan View**

